

INSTRUCTION MANUAL

General Description

This vertical antenna is designed for operation on 10, 15 and 20 meters. It is designed to work against earth ground or a radial ground system. When used in conjunction with a resonant radial system, the vertical antenna becomes very efficient with a low angle of radiation and excels in DX communications. A simulated radial ground system (Model 14 RMQ, Order No. 184) is available from your Hy-Gain dealer. This manual tells you how to construct your own radial system. The 12AVQ-S now features stainless steel hardware for all electrical and most mechanical connections.

NOTE: If you mount the antenna, then find the roof space is too small for the radial system, you can droop the radials over the roof at almost any angle without seriously changing the performance of the antenna.

WARNING

When installing your system, take extreme care to avoid any accidental contact with power lines or overhead obstructions. Failure to exercise this care could result in serious or fatal injury.

Construction

It is designed to fit a 1 5/8" mast. A 1 1/4" plumbers pipe has a 1 5/8" outside diameter and is highly recommended for masting material. This is the minimum roasting material which will meet the severe weather survival specifications of this antenna. The warrantv. is void if a lighter mast is used.

The Model 12AVQ-S is made of high quality seamless aluminum tubing for maximum strength. The Hy-Q traps are durable and highly weather resistant.

Specifications

Mechanical

Overall Height.....	13' 5 3/8" maximum (4099 mm)
Wind Survival	80 mph (128.8 kmph)
Mast Bracket Accepts.....	1 5/8" outside diameter (41 mm)
Net Weight.....	9 lbs. (4 kg) approx.
Hardware.....	18-8 stainless steel except for 2 U-bolts
Element Tubing Clamps	stainless steel

Electrical

Input Impedance	50 ohms
Frequency.....	10, 15 and 20 meters
SWR at Resonance	less than 1.5:1
Maximum Power Input.....	maximum legal
Lightning Protection.....	DC ground
Feedpoint Termination.....	SO-239

SWR and Feedline

The Model 12AVQ-S antenna is designed to match 50 ohm coaxial transmission line. By following our detailed instructions and measuring accurately, an SWR of 1.2:1 or better at resonance may be obtained. An SO-239 coax receptacle is mounted in the base of the antenna for maximum weather protection.

NOTE: If the input terminals of the SO-239 input connector are checked with an ohmmeter, they will show a direct short. *This is normal.*

Assembly

To become familiar with the antenna and to simplify the assembly, read through the entire manual before beginning.

Unpack the parts and check them against the Parts List and drawings.

Determine where to mount your antenna (rooftop or ground) and what mode of transmission to use (Phone or CW). Take note of the dimensions in the manual. For the antenna to operate at peak efficiency, these measurements *must be accurate*. The typical VSWR chart should help you decide the best mode for your purposes.

CAUTION

Do not try to adjust one band for Phone and another for CW or the antenna will not operate properly. All bands must be set for CW or for Phone.

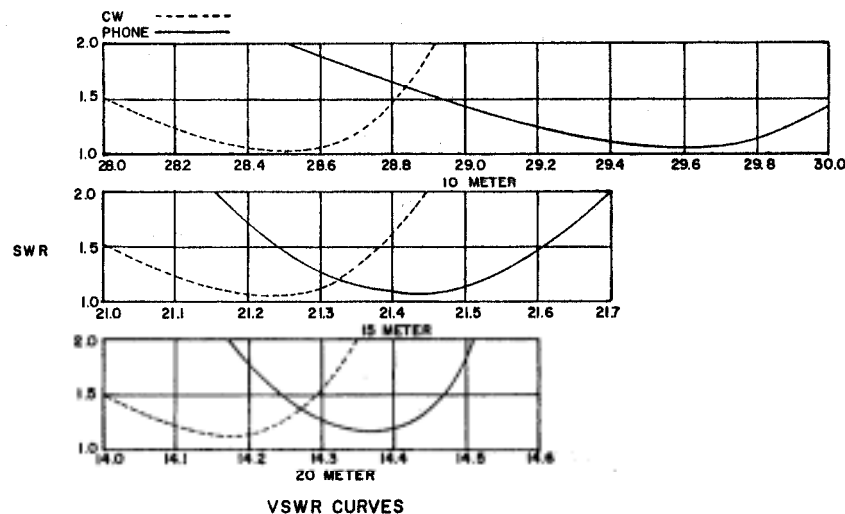

Figure 1
Typical VSWR Chart

Select the base assembly (Item No. 4) and the #16 compression clamp (Item No. 8) Slip it on the end of the base assembly. Do *not* tighten at this time.

Installation of the Tubing Clamps

Take care when measuring the tubing lengths for your mode of transmission.

Select the proper size tubing clamp as shown in the chart. When installing the clamps, place the clamp near the tube end with the top of the clamp over the slot in the tube as shown in Figure 2.

After adjustment of the tubing lengths, tighten the clamp with a 5/16 inch nut driver, socket, or open end wrench until the tubing will not twist or telescope.

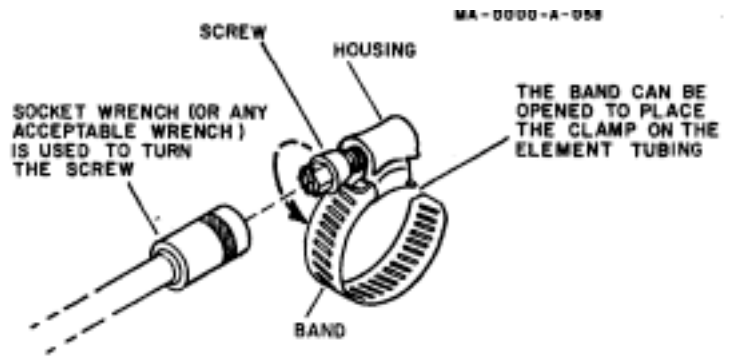
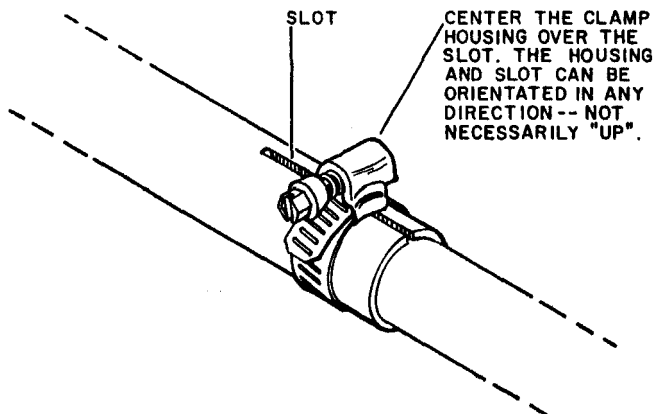

Part No.	Description	Fits Tubing Sizes
358756	Clamp, Size #6 all stainless steel 5/16" hex head screw	1/2 and 3/4"

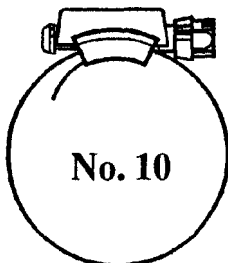

Part No.	Description	Fits Tubing Sizes
358757	Clamp, Size #10 all stainless steel 5/16 hex head screw	1"

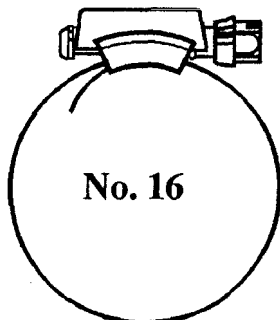

Part No.	Description	Fits Tubing Sizes
358758	Clamp, Size #16 all stainless steel 5/16 hex head screw	1 1/4"

Figure 2 Tubing Clamps

Select the M2 section (Item 1) and slip it into the base assembly. Measure Dimension "W" shown in Figure 3 according to your mounting location and mode of transmission. Now tighten the compression clamp *slightly*.

Select the #10 tubing clamp (Item 9) as shown in Figure 2. Slip the clamp over the M2 section but do *not tighten as this time*.

Select the 10-meter trap (Item 5) and slip it into the M2 section with the plastic cap at the top. Measure 2 1/4 inches from the edge of the M2 section to the bottom of the trap as shown in the illustration (Dimension "B"). Now tighten the clamp *slightly*.

Select the M3 section (Item 2) and a #10 tubing clamp and slip it onto the M3 section. Now slip the M3 section (end with clamp installed) over the 10-meter trap and measure Dimension "C" according to your mounting location and mode of transmission. Tighten compression clamp *slightly*.

Select the remaining #10 tubing clamp and slip it over the M3 section.

Select the 15-meter trap (Item 6) and slip it into the M3 section with the plastic cap at the top. Measure Dimension "D" according to your mounting location and mode of transmission. Tighten compression clamp *slightly*.

Select the #6 tubing clamp (Item 7) and slip it over the 15-meter trap.

Select the M4 section (Item 3) and slip it into the 15-meter trap. Measure Dimension "E" according to your mounting location and mode of transmission then tighten the compression clamp slightly.

Carefully recheck all dimensions - then tighten all compression clamps *securely*.

Place the 7/16" caplug (Item 10) on the end of the antenna.

Install the two (2) U-bolts (Item 13) using the 5/16" nuts and lockwashers (Items 16 and 19) as shown in Figure 4.

Select the four (4) 1/4"-20 x 3/4" screws, nuts and lockwashers (Items 12, 17 and 20) and install on the base assembly. If the antenna is to be ground mounted, tighten these screws securely. If the antenna is to be roof mounted, refer to Figure 5 before tightening these screws. *A radial system must be added for proper operation when this antenna is mounted on the roof.* This radial system can also act as the guying system. The radials should be the length shown in Figure 6 after the strain insulators are installed. If you prefer, you may obtain a radial system specifically designed for your 12AVQ-S by asking your local Hy-Gain dealer for the 14RMQ.

CAUTION

If copper is used for the radials, solder lugs must be used to prevent dissimilar metal corrosion from occurring.

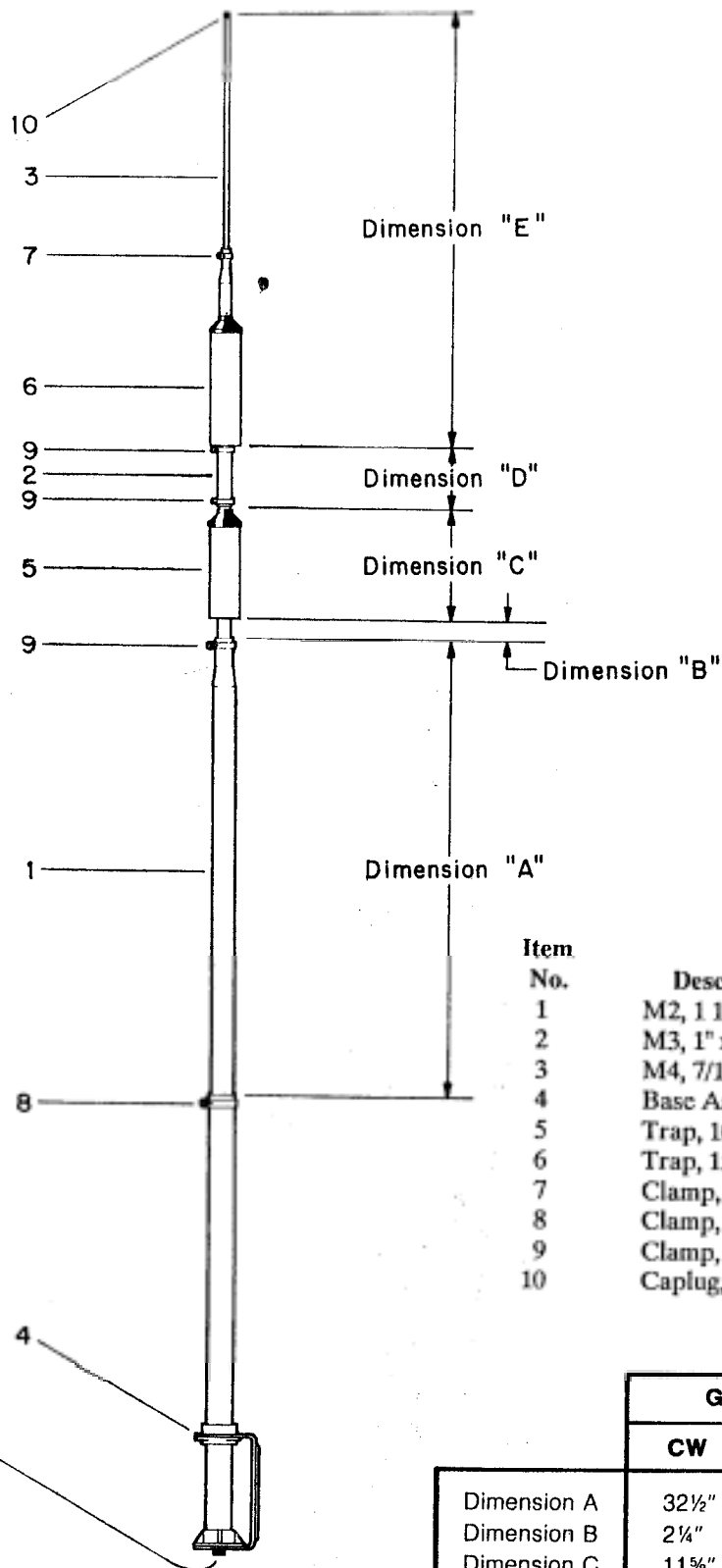

- | Item No. | Description |
|----------|---------------------|
| 1 | M2, 1 1/8" x 60" |
| 2 | M3, 1" x 6 1/2" |
| 3 | M4, 7/16" x 28 3/4" |
| 4 | Base Assembly |
| 5 | Trap, 10 Meter |
| 6 | Trap, 15 Meter |
| 7 | Clamp, #6 Tubing |
| 8 | Clamp, #16 Tubing |
| 9 | Clamp, #10 Tubing |
| 10 | Caplug, 7/16" |

SO-239 Connector;
Requires PL-259
(NOT SUPPLIED)

	Ground		Roof	
	CW	Phone	CW	Phone
Dimension A	32 1/2"	26 1/2"	47"	39 1/2"
Dimension B	2 1/4"	2 1/4"	2 1/4"	2 1/4"
Dimension C	11 5/8"	11 5/8"	11 5/8"	11 5/8"
Dimension D	7 1/8"	7"	7"	7"
Dimension E	44 3/4"	44 3/4"	45 3/4"	45 3/4"

Figure 3 Overall view with Callouts and Dimensions

Ground your radial system by connecting the base of the antenna to proper ground using #10 or larger copper or aluminum wire. A proper ground consists of an 8 foot copper clad, steel ground rod driven into the ground as close as possible to the antenna base.

If the antenna is ground mounted, install as shown in Figure 4. Ground the base of the antenna as described above.

This hole is not used in this application

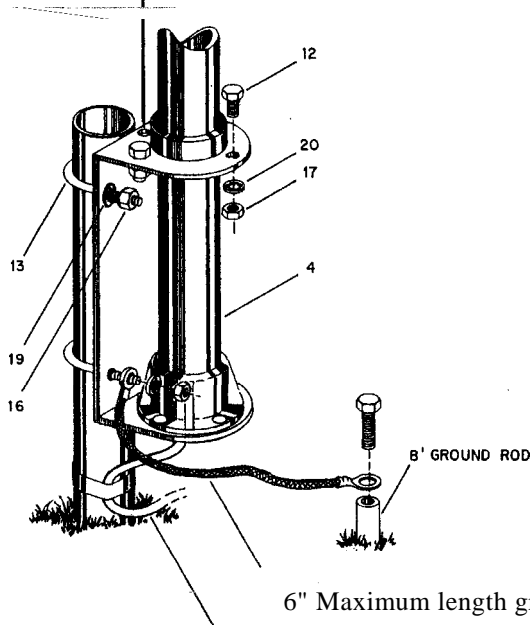

6" Maximum length ground wire (Not Supplied)
52 Ohm coaxial cable (Not Supplied)

Item No.	Description
4	Base Assembly
12	Bolt, hex head, 1/4"-20 x 3/4"
13	U-Bolt, 5/16" x 1 5/8" x 2 1/4"
16	Nut, hex, 5/16"-18
17	Nut, hex, 1/4"-20
19	Lockwasher, split, 5/16"
20	Lockwasher, internal, 1/4"

NOTE: For improved performance, use more ground rods. Any good electrical connection can be used. (Not Supplied).

Figure 4 Ground Base of Antenna

WARNING

Connect the coaxial cable as shown in Figures 4 and 5. Weatherproof the connection using Coax-Seal® or some similar substance to prevent water from ruining the coax.

Keep this antenna out of reach of children or pets. The antenna radials are hot with rf proportional to the operating power.

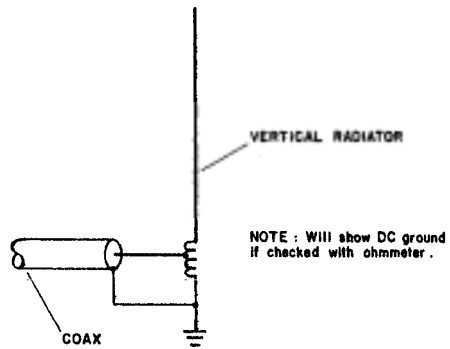

Figure 7 Schematic of Antenna Base

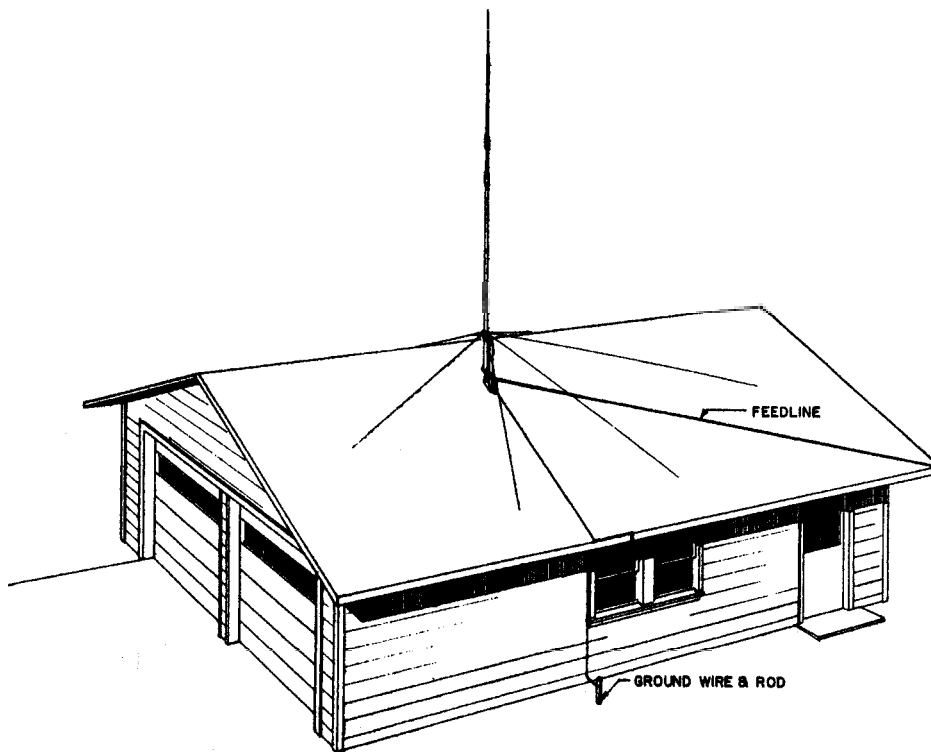

Figure 8 Completed Roof Mount Installation of the 12AVO

Final Adjustment for Setting the 12AVQ-S, 14AVQ-S and 18AVT-S Antennas

1. The antenna operates progressively from 10 thru the lowest band available. Even though you may not be using 10 meters at the present time, 10 meters must be adjusted because any adjustment made between the base and the first trap automatically changes all of the bands at a later date.
2. Because every antenna installation is influenced by the soil conditions and the proximity effect of nearby objects, the dimension in the manual must be fine tuned to put the antenna exactly where you want it on each band.
3. Beginning on 10 meters, make a VSWR curve checking the low end, center, and high end of the band. This will indicate if the antenna favors the low end or the high end as installed.
 - A. If it favors the low end, shorten the 10 meter adjustment one inch (1") or no more than 1 1/2 inches. Run another VSWR measurement. You will now have an indication of how far the adjusted distance tuned the antenna in your location. Additional adjustments are indicated by the VSWR curve to put 10 meters exactly on the portion of the band you desire as your center operation frequency.
 - B. If the antenna favors the high end, lengthen the dimension correspondingly to move the antenna to a lower frequency as outlined above.
4. Next, repeat this same procedure for 15 meters to put that band on frequency.
- 5: The same procedurd is then used to stt up the 20 meter band, as well as the remaining bands available, depending upon the model involved.
6. Most verticals are monopole antennas or half of a dipole. For this reason, the soil conditions, when the antenna is ground mounted, are important as it makes up the other half of the antenna. When you roof mount the antenna, radials must be used as outlined in the assembly instruction manual to provide the other half of the antenna.

PARTS LIST

Item

No.	Part No.	Description	Otv
2	190605	M3, 1" x 6 1/2".....	1
3	178416	M4, 7/16" x 28 3/4"	1
4	877128	Base Assembly.....	1
5	877132	Trap, 10 Meter.....	1
6	878417	Trap, 15 Meter.....	1
	872012-1	Parts Package 384S, Stainless Steel	1
7	358756	Clamp, #6 tubing	1
8	358758	Clamp, #16 tubing	1
9	358757	Clamp, #10 tubing.....	3
1	455644	Caplug, 7/16	1
1		(Not Used)	
1	505266	Bolt, hex head, 1/4"-20 x 3/4"	4
1	543792	U-Bolt, 5/16" x 15/8" x 21/4"	2
1		(Not Used)	
1		(Not Used)	
1	555747	Nut, hex, 5/16"-18.....	4
1	554099	Nut, hex, 1/4"-20	4
1		(Not Used)	
1	564792	Lockwasher, split, 5/16".....	4
2	562961	Lockwasher, internal, 1/4".....	5
2	565697	Lockwasher, internal, #10	2

Use this scale to identify lengths of bolts, diameters of tubes, etc. The American inch (1") cm and foot (1') can be converted to centimeters in this way.

1 inch (1") = 2.54 cm

1 foot (1') = 30.48

Example:



FRACTION AND METRIC EQUIVALENTS FOR ONE INCH			
Fractional Inch	Millimeters	Fractional Inch	Millimeters
1/16	1.588	9/16	14.288
1/8	3.175	5/8	15.875
3/16	4.700	11/16	17.463
1/4	6.350	3/4	19.050
5/16	7.937	13/16	20.638
3/8	9.525	7/8	22.225
7/16	11.112	15/16	23.813
1/2	12.700	1	25.400

ADDENDUM

AMATEUR PHASING

ENGINEERING REPORT

**PHASED MULTI-BAND
VERTICALS** for ADDITIONAL GAIN and
LOW ANGLE RADIATION

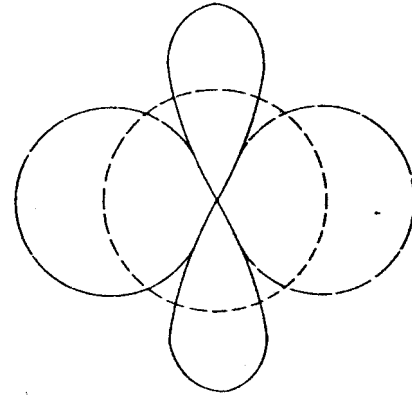

Phased Patterns

INTRODUCTION

The following Hy-Gain verticals are well adapted for the phasing arrangements shown in this report.

MODEL 18HT-S HY-TOWER

The 18HT-S is a multi-band vertical antenna with automatic band selection of 10-80 meters by means of a unique stub decoupling system. The Hy-Tower with a base loading coil operates efficiently on 160 meters. The system is foolproof, fed directly with a single 50 ohm coax. No guys are required for the 24 feet high, self-supporting tower. The top mast extends the height to 50 feet. Two units make an ideal phased array.

MODEL 18AVT/WB-S

The 18AVT/WB-S is a multi-band trap vertical for 10 through 80 meters. It is completely factory **pre-tuned and exhibits an extremely low angle** DX radiation pattern. It is easy to assemble, light weight which one man can install. A single 50 ohm coaxial feedline is required. Two or three 18AVT/WB-S's make an excellent phased array.

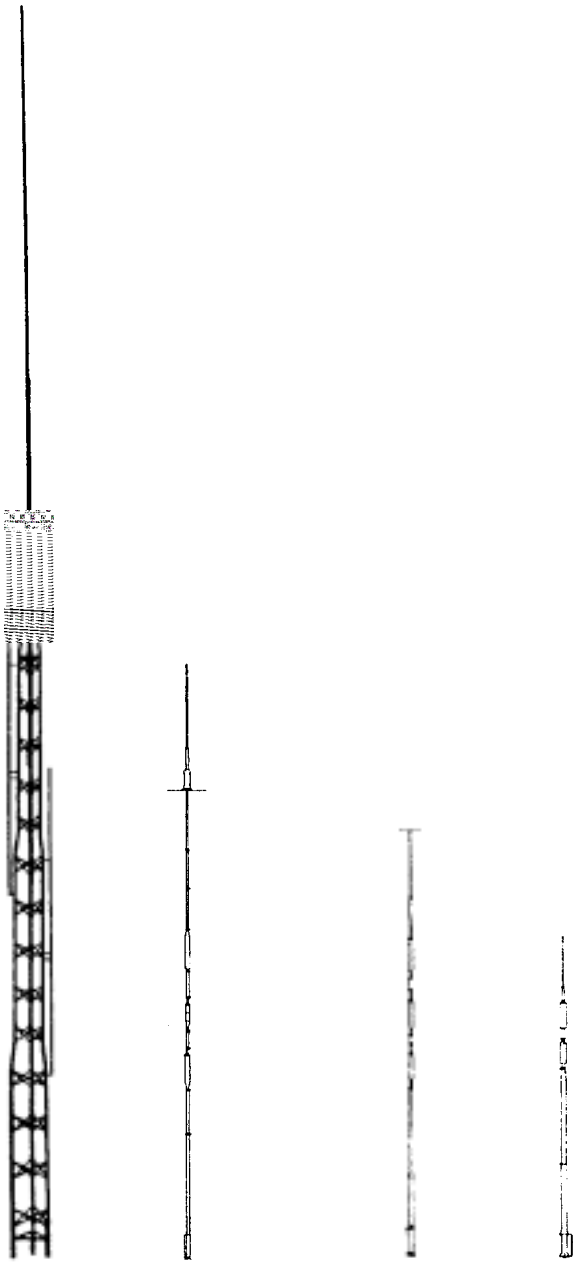

AV-18HT AV-18VS/18AVT AV-14AVQ AV-12AVQ

MODEL 14AVQ/WB-S

The 14AVQ/WB-S is a self supporting multi-band trap vertical for 10 through 40 meters and is completely factory pre-tuned. It is the world's most popular ham antenna with an overall height of 19 feet. The antenna is thoroughly weatherproofed and has a low angle DX radiation pattern. It may be ground mounted or installed on "Roof Top" with a radial system.

MODEL 12AVQ

The 12AVQ is a self supporting 13 1/2 foot multi-band trap vertical for 10, 15 and 20 meters. Completely factory pre-tuned with SWR of 2:1 or less with a low angle DX radiation pattern. The antenna has a new fiberglass impregnated styron base insulator. It may be ground mounted with earth acting as the "image antenna" or installed on the roof using a radial system.

DESCRIPTION

Increased activity on 80 and 40 meters has created a need for an antenna with power gain and directivity. Doublet and long wire antennas are no longer effective due to increased QRM. At these low frequencies, the radiation system must be lengthy and height above ground is extremely important to obtain the "low" angle of radiation needed for DX.

Part 1 - SINGLE BAND

BI-DIRECTIONAL ARRAY (Four Quadrants)

THEORY' OF OPERATION

Two identical vertical antennas can be installed as a phased array. When excited by RF energy, gain is achieved by control of the directional pattern. This direction pattern control results in added gain by sharpening lobe patterns and concentrating the radiated energy at very low angles. Signal flutter is reduced and reception is vastly improved.

Beams are excellent, but require a large supporting tower and "hefty" rotating system. Inverted V dipoles and slopers require a large tower and plenty of property.

The vertical "phased array", the answer for "DX" on these frequencies combine gain, directivity and low angle radiation, the three most important DX factors in a communication installation. The vertical is well known for its low angle characteristics. When you combine two identical verticals, properly spaced and phased, the resultant is a concentrated low angle of energy and a power gain. These antennas can be so arranged to give a definite effect on either one or two favorite bands or all band coverage with some pattern compromise and slight loss of gain.

The following data was experimentally derived on the Telex/Hy-Gain test range. Due to the many factors that vary and influence the performance of an antenna, such as grounding and close proximity of surrounding objects, etc., Telex/Hy-Gain cannot guarantee an installation to perform or exhibit the same characteristics as outlined in this report. However, many Amateurs are now successfully using these arrangements. Commercial broadcast stations have been using a similar phasing arrangement for years.

Phased arrays will reduce installation height requirements and still maintain low angle radiation.

Most effective spacing for a bi-directional array is 1/2 wave length. When two verticals are excited in phase the radiation is broadside to the plane of the verticals, offering substantial gain and bi-directional characteristics. Side nulls offer excellent signal cancellation to the undesired direction.

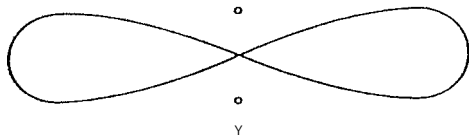

When excited "out of phase" these same verticals can be made to give an "end fire" or bi-directional pattern in the opposite direction through the plane of the verticals. This then nulls out signals in the opposite directions. More gain is exhibited by the broadside pattern over the "end fire" arrangement, but the "end fire" arrangement offers a wider frontal pattern.

Both arrangements offer an excellent advantage over a single vertical since either phasing combination exhibits noticeable signal gain with side attenuation of undesired signals. This added gain and low angle vertical directivity is the advantage of the phased array.

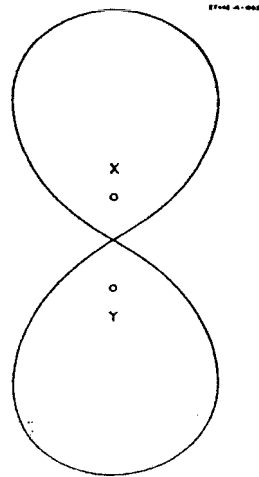

"ENDFIRE" GAIN 23 dB

Phased verticals may be spaced either one quarter wave or one half wave depending upon gain and directional characteristics. The nulls of the phased array are extremely sharp and very pronounced. Typical arrangements of phased arrays and their electrical specifications are illustrated below.

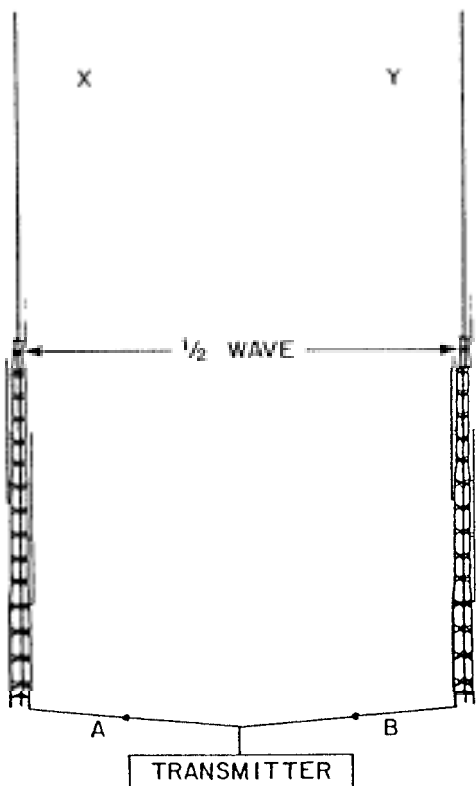

When feedline "A" is the same length as feedline "B" the currents arrive at the base of each antenna at the same time, giving the "inphase" broadside pattern.

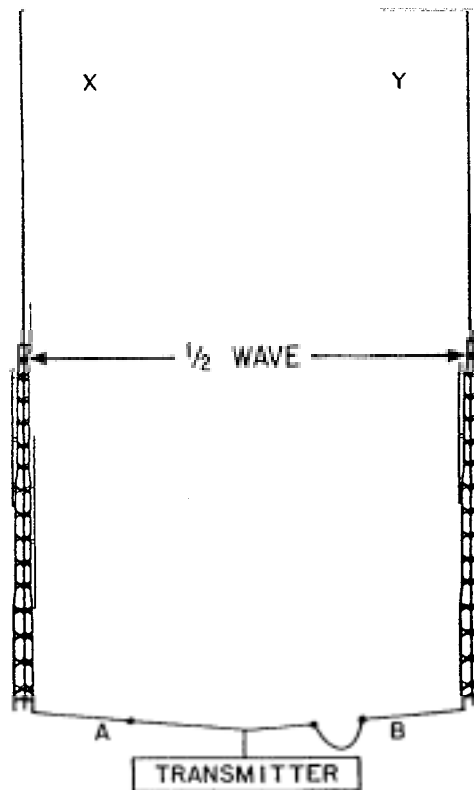

When feedline "A" is 1/2" wave length shorter than feedline "B" the current arrives at antenna "X" 1/2 wave length sooner (180 degrees) than at antenna "Y" giving the "out of phase" end fire pattern.

Figure 1

SPECIFICATIONS

	Broadside	End Fire
Pattern width, half power points	60 degrees	80 degrees
Gain over single vertical	3.86 dB	2.3 dB
Side attenuation	30 dB	20 dB
Impedance	50 Ohms	50 Ohms
Directional characteristics	Bi-Directional	Bi-Directional

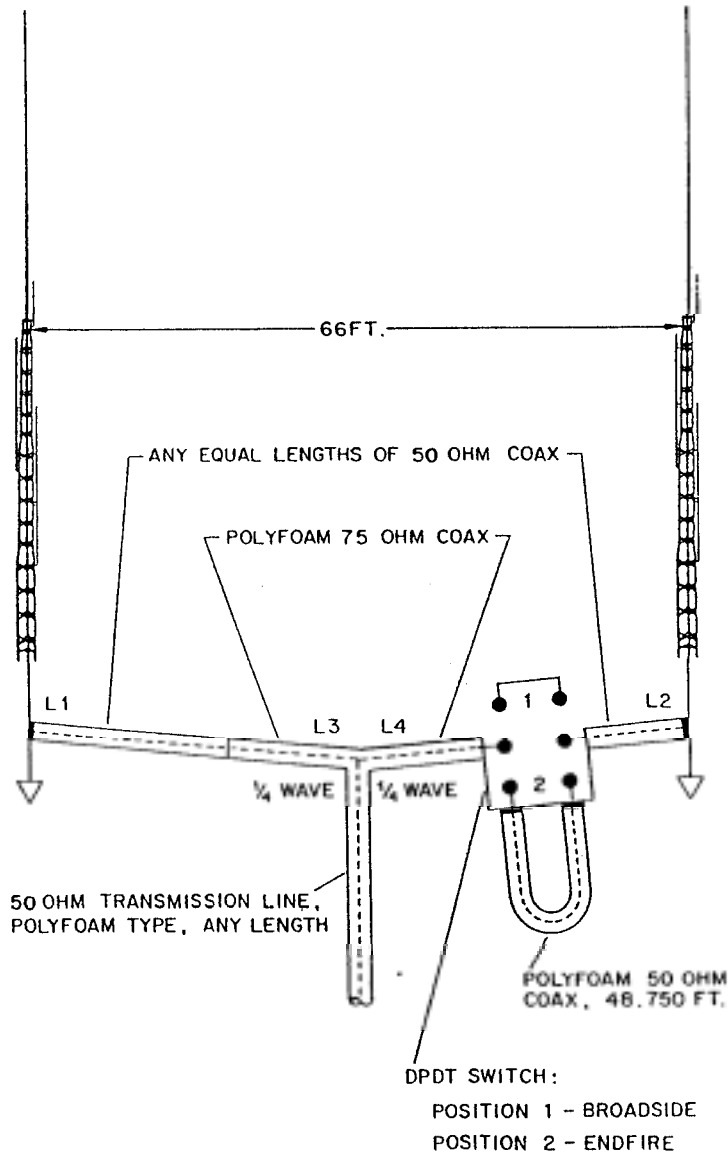
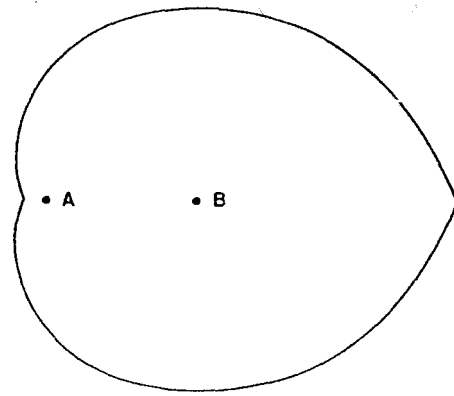

Figure 2
 Typical Installation Phased (2) 18 HT 40 Meters
 7200 KHz Design Frequency

CARDIOID ARRAY (Uni-directional)

When two or three identical verticals are excited directly and fed 90 degrees out of phase with a spacing of $1/4$ wave length, a cardioid pattern results. This pattern may be switched in either direction. By inserting a $1/4$ wave length delay line the antenna will "fire" or be directive to that particular element. ∴



TWO VERTICALS

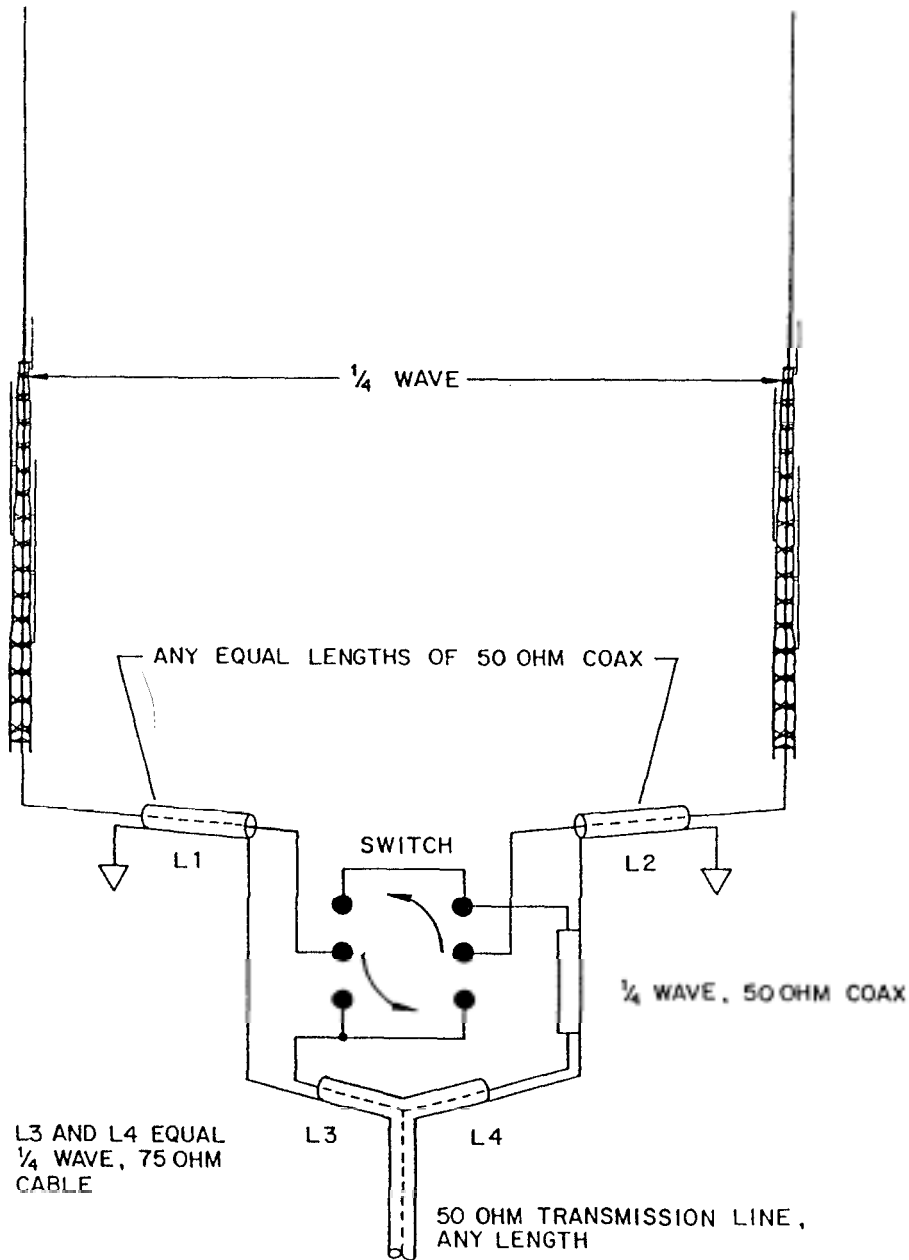
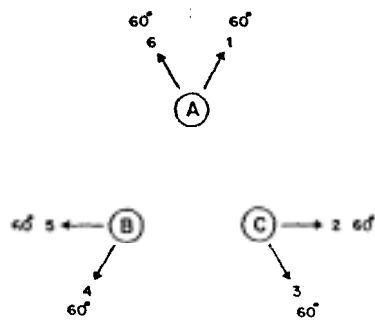

Figure 3
Cardioid-Unidirectional With Two Selectable Directions

The beam pattern for two 1/4 wave length verticals will be approximately 120 degrees. An arrangement of three switchable verticals gives a 60 degree pattern in six selectable directions.



TOP VIEW - 3 VERTICALS

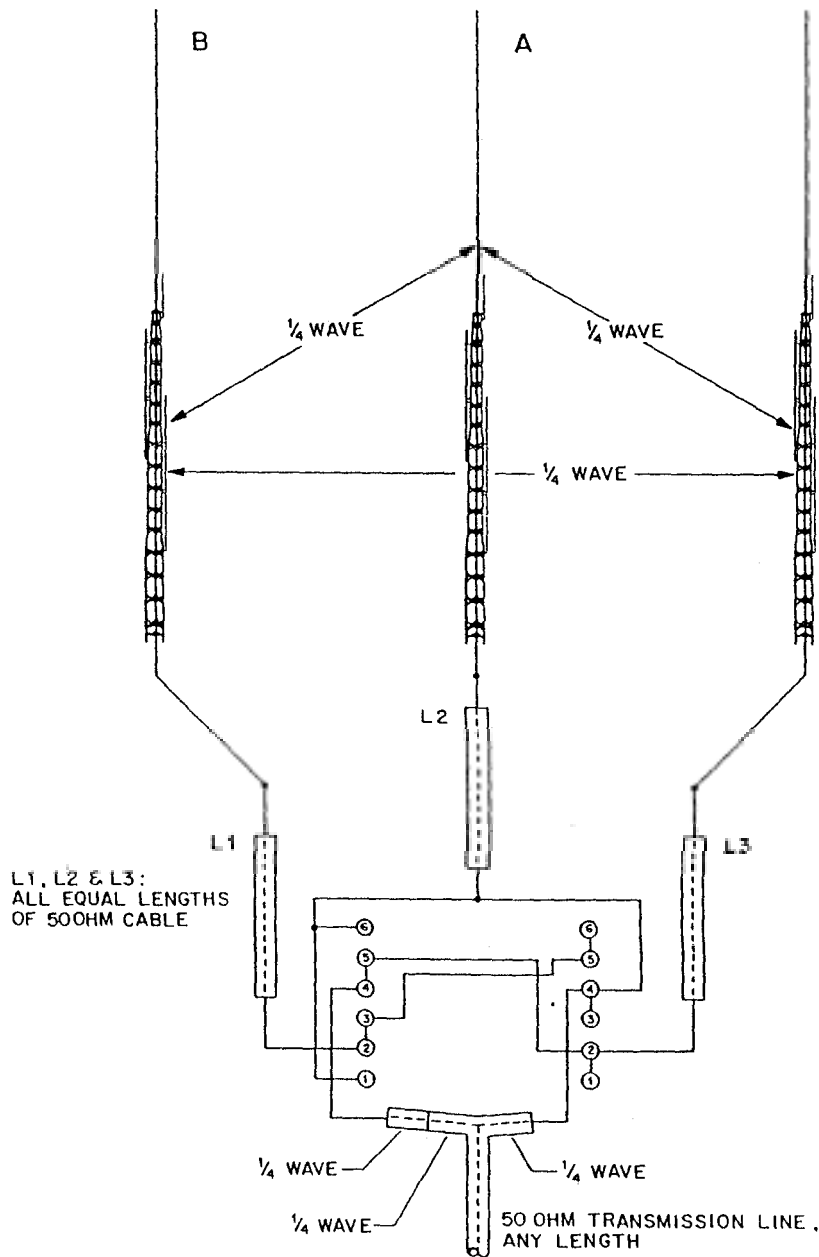

Figure 4
360 Cardioid Arrangement

ELECTRICAL SPECIFICATIONS:

	Two Phased Verticals	Three Phased Verticals
Pattern Width, half power points	120 degrees	60 degrees
Gain over single vertical	4.5 dB	4.5 dB
Side attenuation	20 dB	20 dB
Rear attenuation	30 dB	30 dB
Impedance	50 Ohms	50 Ohms
Directional Characteristics	Uni-directional	Uni-directional

VSWR: Exceptionally low SWR is present with a phased array. If phasing lines are correctly measured and the terminal impedance of each antenna is very close to 50 Ohms: Typical SWR: Broadside 1.2:1, Endfire 1.4:1, Cardioid 1.2:1.

P H A S I N G L I N E S :

The 1/4 and 1/2 wave transformers, identified as L3, L4 and L5 are calculated from the following formula:

$$\text{1/4 wave} = \frac{246000 \times \text{vel. factor - reg. coax.}}{\text{frequency (in KHz)}} \times 0.66$$

EXAMPLE:

$$\begin{aligned} \text{1/4 wave at 7200 KHz} &= 246000 / 7200 = 34.16 \\ &\quad \times .75 \\ &= 25.62 \end{aligned}$$

1/4 wave = 25.62 ft.

PART 2 - MULTI-BAND OPERATION

M U L T I - B A N D I N G

Multi-banding is easily accomplished by choice spacing two identical verticals. (refer to charts A,B, and C and associated Figures 1 through 5) Switchable 1/4 wave length and 1/2 wave length phasing cables must be employed for each band. These cables can be placed in the station in any suitable fashion along with a manual switching arrangement or relay system.

RADIATION PATTERN:

Consideration must be given to the fact that 1/2 wave spacing (optional) is ideal for phasing. When multi-banding with close and wide spacing, compromise radiation patterns must be expected. In most cases a choice spacing serves 3 bands most effectively with good directional characteristics, added gain and low angle performance.

OPTIONAL SPACING

Various antenna spacings may be selected from charts A, B, and C, for single band, duo band or multi-band arrangements. Associated radiation patterns for a specific spacing is shown in Figures 1 through 5 for each band.

If the $3/4$ wave length patterns are not desirable, a single vertical only can be switched in use to obtain an omni-directional pattern.

INSTALLATION

The vertical antenna requires a minimum amount of space. Ground mounted or elevated arrays are easily installed.

Antenna placement and orientation is a most important factor when planning maximum effectiveness in desired directions. Each vertical should be installed in the clear relatively free of surrounding objects in order to maintain its design 50 Ohm terminal impedance.

Each antenna must be mounted at the same height on or above ground and be so arranged according to their radiation pattern to offer desired directivity.

The phased array is primarily designed for long range and DX communications. In cases where close and medium distance contacts are hampered by the array's low angle characteristics and a higher angle is required, switching arrangements can select one vertical for this coverage.

SWITCHES & CONNECTORS

Low loss constant impedance type coaxial switches and connectors should be used when splicing phasing lines. B&W multi-position, single or multi-gang coaxial switches with Amphenol coaxial cable and "T" connectors are recommended.

FIELD TESTS

Actual field tests comparing one vertical to the phased array results in doubling the receiver sensitivity and offering up to 12 dB of signal increase. An attenuation of up to 30 dB is noticeable on the phased verticals with half wave spacing. With quarter wave spacing, up to 20 dB cardioid, and 30 dB front-to-back attenuation can be obtained.

"End Fire" directivity offers a larger area of radiation at slightly reduced gain as compared to the broadside arrangement. The "broadside" arrangement is recommended for communications at greater distances whereas the "endfire" arrangement would be so arranged to cover a larger area of communications. Special attention to the coax phasing line lengths and their proper placement is of utmost importance.

- A. 80 meter bi-directional pattern (all SW positions 3) refer to Figure 1, Part 2 "Radiation Patterns"

NOTE: Due to close electrical spacing (1/4 wave) on 80 meters for Broadside (position 1) and Endfire (position 2) the SVWR may be somewhat higher than 1/2 wave spacing. SW3 selects direction

- B. 40 meters all switches in position 1 selects Bi-Directional patterns. Use SW2 for broadside (position 1) 1) Endfire (position 2).

- C. All switches in position 2 selects cardioid pattern. SW4 selects direction of cardioid pattern.

NOTE: All connecting lines are exaggerated in length. These lines must be direct and short as with any coax hook-up practice.

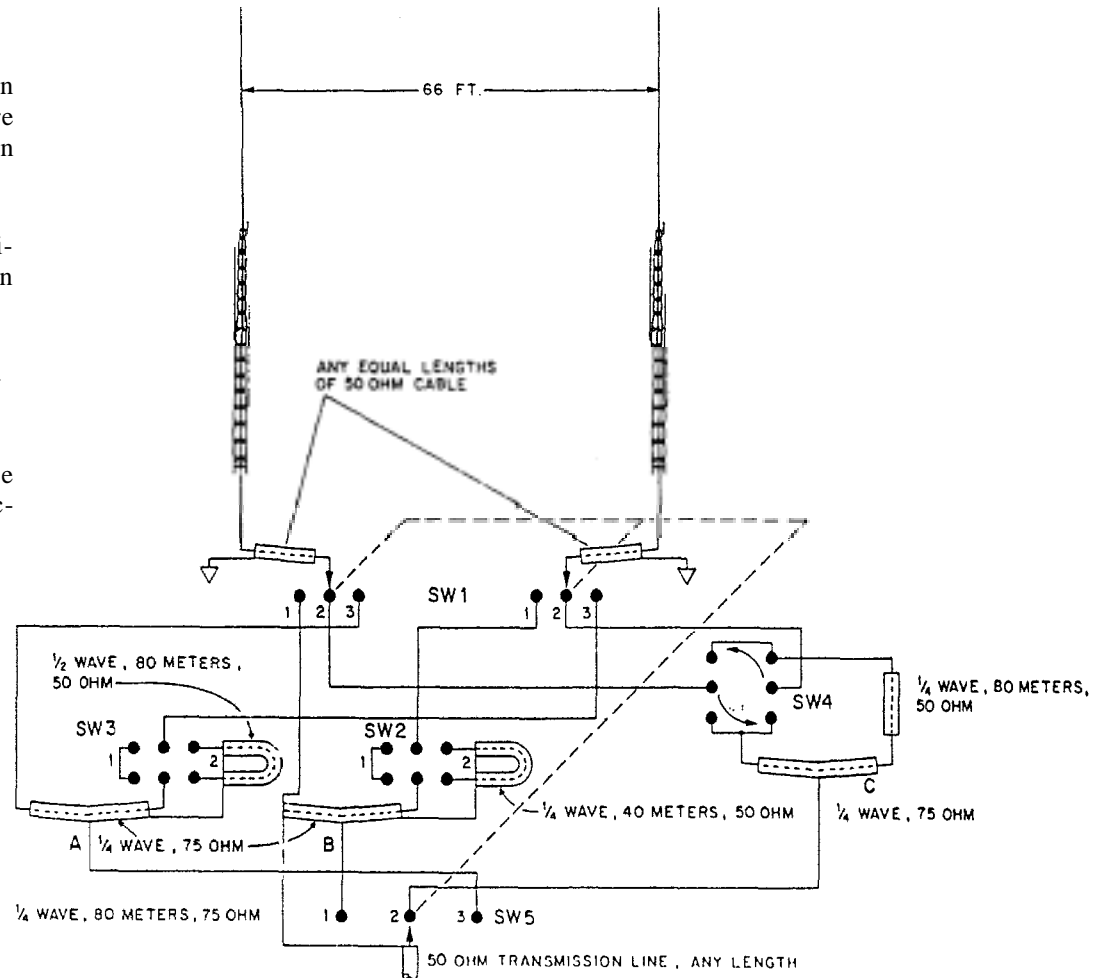
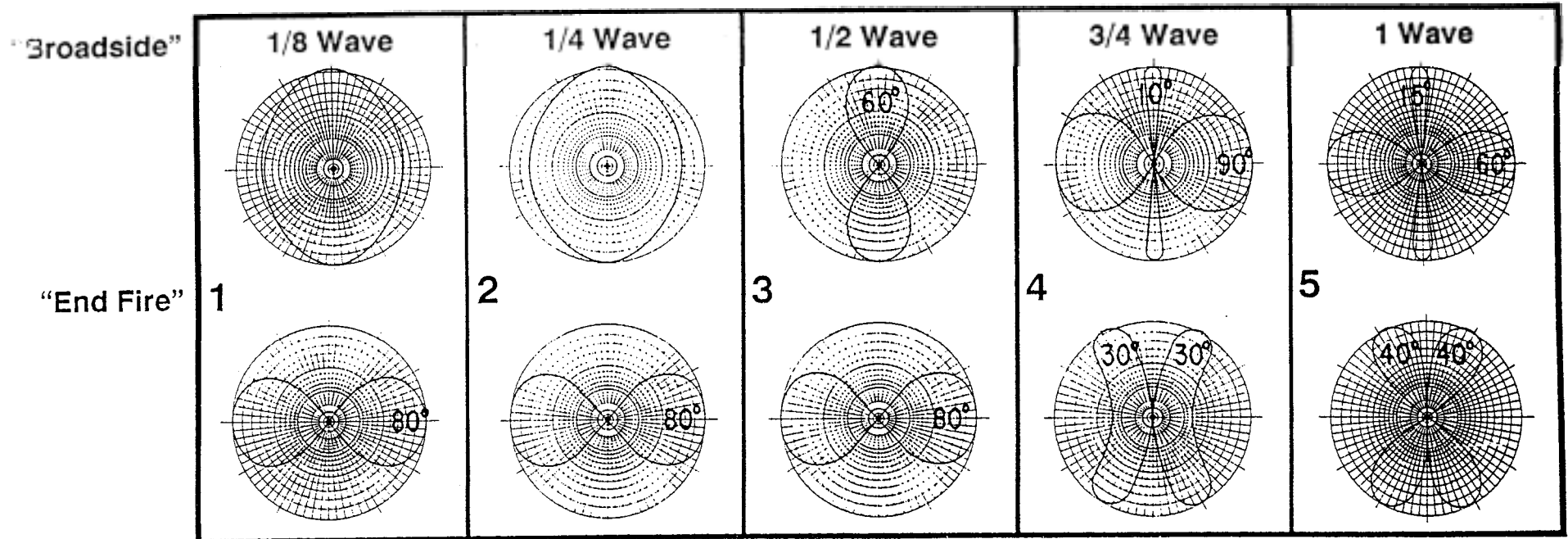

Figure 5
 Typical installation (2) 18HT-S Phased for 80 and 40 Meters Selectable Broadside and Endfire Patters on 40 Meters Selectable Broadside and Endfire Patterns on 80 Meters Selectable 2 Directions Cardioid on 80 Meters



PATTERN CHART
Single Band Arrangement

Spacing		PATTERN CHART				
A	125'			80		
	66'			40		
	33'			20		
Dou Band Arrangement						
B	66'		80	40		
	33'		40	20		
	16'		15	10		
Multi-band Arrangement						
C	33'	80	40	20	15	10
	66'		80	40	20	

Note: Corralate Patterns to spacing used in installation

Figure 6
Radiation Patterns - Typical Spacing For Broadside And Endfire Arrangements